

7030 CATCH BASIN CURB INLET

Heavy duty
 With Type M2 grate and T1 back
 260 sq. in. open area
 Curb back height adjusts from 3 1/4" to 9"
 "DUMP NO WASTE!" lettering and fish image
 Drive over curb inlet frame — 7030Z2

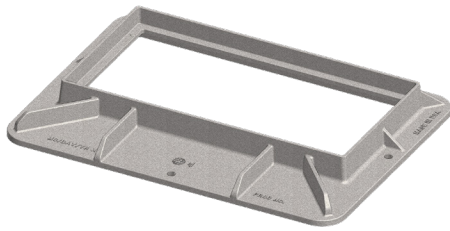

7030Z2 Drive Over Curb Inlet Frame

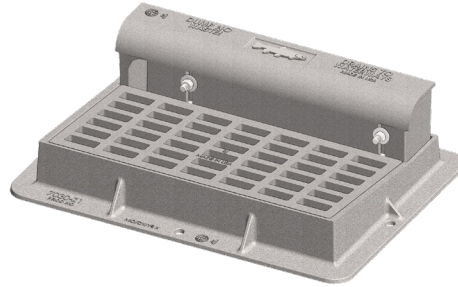
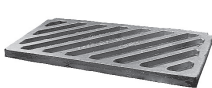
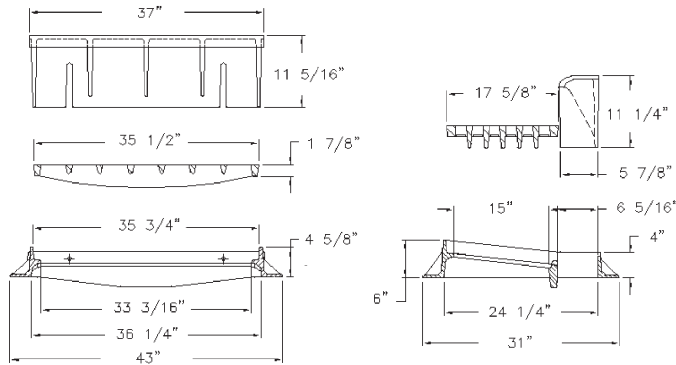

Type M3 Diagonal Bar Grate
 Approx. 315 sq. in. open area
 2 1/8" wide opening between bars



Type M4 Vane Grate
 Approx. 260 sq. in. open area



Type M5 Diagonal Bar Grate
 Approx. 225 sq. in. open area
 1 1/4" wide opening between bars

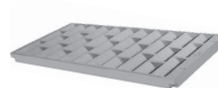

Type M6 Vane Grate
 Approx. 260 sq. in. open area



Type M10 ADA Grate
 Approx. 140 sq. in. open area
 "DUMP NO WASTE!" lettering and fish image



Type T2 Back
 12" curb radius,
 Height adjusts 4" to 9"



Type T3 Back
 12" concave curb radius
 No curb Adjustment



Type T4 Back
 3" curb Radius
 Height adjusts 6" to 11"
 "DUMP NO WASTE!" lettering and fish image

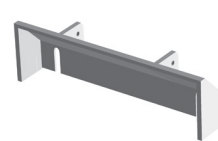

Type T5 Back
 No curb radius
 Height adjusts 4 1/2" to 8"

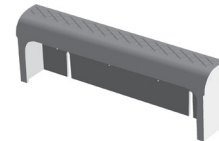

Type T6
 3" curb radius
 Height adjusts 6" to 10"
 "DUMP NO WASTE!" lettering and fish image



Type T7 Back
 Roll curb no curb adjustment

Supplied By:



877-903-7246

www.trenchdrainsupply.com